

## High pressure blower type HD240



- Type:** Side channel blower
- Configuration:** In the standard version, the fan on the intake side has a stainless steel filter that can be used after cleaning with compressed air. When using a fine filter, the stainless steel filter be removed.
- Features:** The device is suitable for operation with frequency inverters for speed control. If desired, the device can be equipped with a thermistor (PTC), the signal can be evaluated with an optional trip device. The tech. Data remains unchanged.
- Operating temperature:** The operating temperature of the radial pressure may **NOT exceed 60°C/140°F**.
- Ambient temperature:** -20°C/68°F to +60°C/140°F
- Voltage:** 400VAC

### Technical data

Item No.:		5100200
Voltage	VAC	230-400 / 265-460
Frequency	Hz	50 / 60
Motor power	KW	2,2 / 2,55
Current consumption	A	5,1
Volumetric current	m <sup>3</sup> / min	3,65 / 4,42
Pressure difference	Pa	27'000 / 26'000
Speed	rpm	2900 / 3'500
Noise pressure level	LpA (db)	68,8 / 70,8
Weight	kg	26,5
Intake opening	mm	Ø 60 (outside)
Exhaust opening	mm	Ø 60 (outside)
Dimensions	mm (LxBxH)	395 x 327 x 365
Type of protection		IP 54

### Power curve

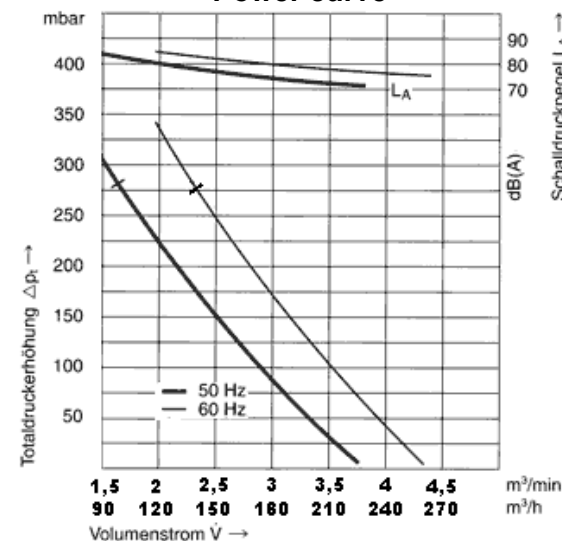













## High pressure blower type HD240

### Permissible vibration values according to ISO 14694

Fan application category [ah]	Rigidly mounted [mm/s <sup>2</sup> ]	
	Peak	r.m.s.
<b>BV-3</b>	<b>4,5</b>	<b>1,8</b>

### Accessories:

Item No.	Description
5107278	 Hose connection adaptor 1 x 60mm inside / 2 x 60mm outside
5107293	 Hose connection adaptor 1 x 38mm inside / 2 x 38mm outside
5207293	 Hose connection adaptor 1 x 38mm / 2 x 38mm – with thread outside
5107288	 PVC air hose – Ø 60mm inside
5107285	 Hose clip for hose Ø 60mm
5107240	 Closure Cap for hose connection adaptor Ø 38mm
5107286	 PVC air hose – Ø 60mm inside
5107287	 Hose clip for hose Ø 38mm
5107241	 Closure Cap for hose connection adaptor Ø 38mm
5110895	 Stainless steel filter for HD240
5125908	 Blowing-off nozzle l = 500mm; outlet opening adjustable; connector Ø 60mm outside; for air heater type L62 and high pressure blower type HD240
5125907	 Blowing-off nozzle l = 300mm; outlet opening adjustable; connector Ø 60mm outside; for air heater type L62 and high pressure blower type HD240

High pressure blower type HD240

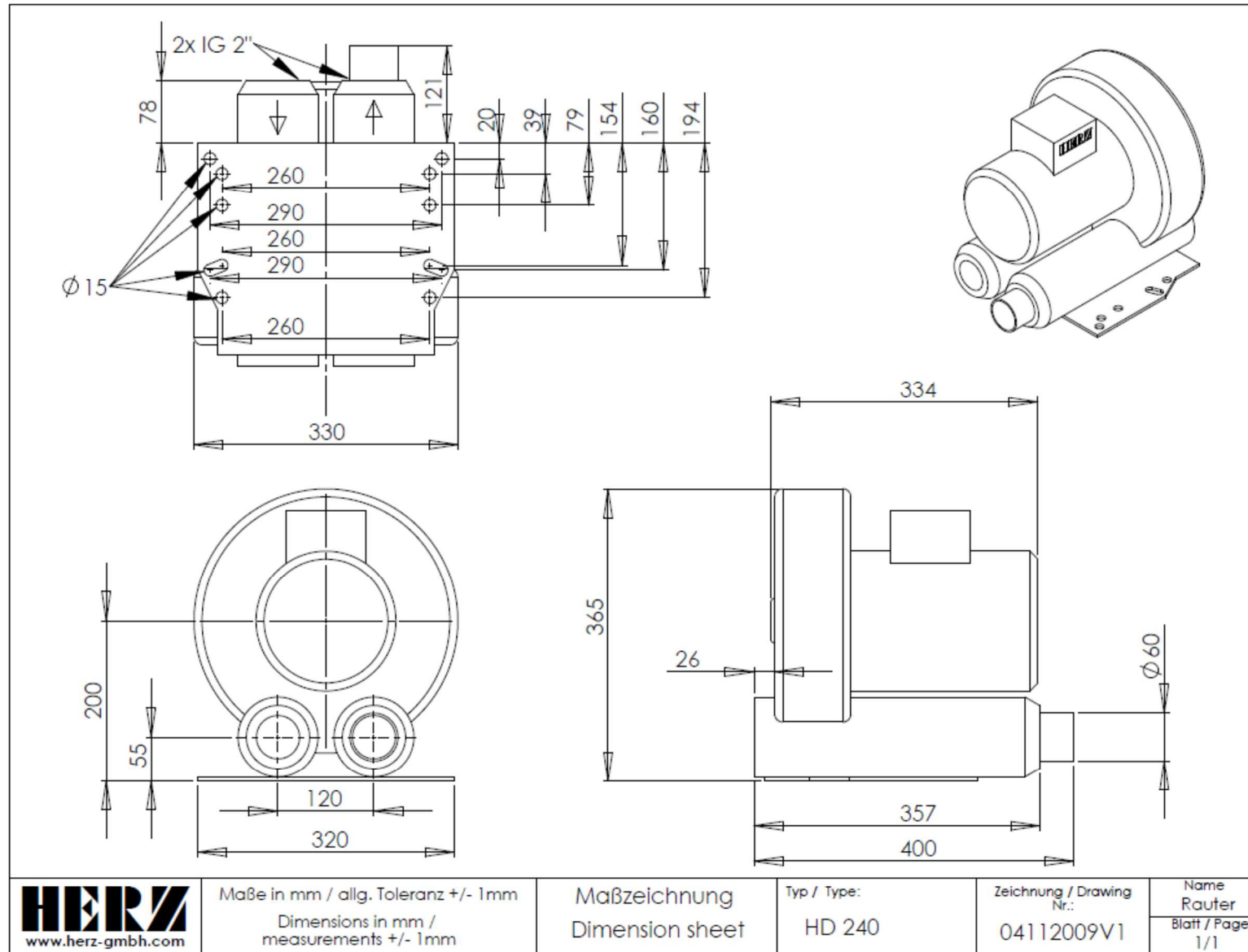

## High pressure blower type HD240

### **HERZ** GmbH

Kunststoff- & Wärmetechnologie  
Biberweg 1  
DE – 56566 Neuwied  
Tel.: +49 (0)2622-8855-0  
Fax: +49 (0)2622-8855-135  
Fax: +49 (0)2622-8855-136  
www.herz-gmbh.com  
info@herz-gmbh.com

### **HERZ** Austria GmbH

Kunststoff- & Wärmetechnologie  
Gleinser Weg 27  
AT – 6141 Schönberg / Tirol  
Tel.: +43 (0)5225-63113  
Fax: +43 (0)5225-6311385  
www.herz-austria.at  
herz.schoenberg@herz-gmbh.com

### **HERZ** Hungária Kft.

Műanyag- és hőlégtéchnika  
Pesti út 284  
HU – 2225 Üllő  
Tel.: +36 (06)29-522400  
Fax: +36 (06)29-522410  
www.herz-hungaria.hu  
herz@herz-hungaria.hu

### **HERZ** Bulgaria OOD

Boul. Assen Yordanov 10  
BG – 1592 Sofia  
Tel.: +359 (0)2-9790351  
www.herz-bulgaria.com  
office@herz-bulgaria.com

### **HERZ** GmbH

Kunststoff- & Wärmetechnologie  
Am Arenberg 26A  
DE – 86456 Gablingen  
Tel.: +49 (0)8230-85085  
Fax: +49 (0)8230-85087  
www.herz-gmbh.com  
robert.einberger@herz-gmbh.com

### **HERZ** Austria GmbH

Kunststoff- & Wärmetechnologie  
Johann-Galler-Str. 20 IZ – NÖ – Nord  
AT – 2120 Wolkersdorf i. Weinviertel  
Tel.: +43 (0)2245-82494-0  
Fax: +43 (0)2245-82494-9  
www.herz-austria.at  
herz.wolkersdorf@herz-gmbh.com

### **HERZ** Polska Sp.z o. o.

Technologie obróbki tworzyw sztucznych  
Ul. Kostrzyńska 30  
PL – 02-979 Warszawa  
Tel.: +48 (0)22-8428583  
Fax: +48 (0)22-8429700  
www.herz.polska.pl  
herz@herz.polska.pl