

## Medium pressure blower type MD14



- Type:** Radial fan
- Configuration:** In the standard version, the fan on the intake side has a stainless steel filter that can be used after cleaning with compressed air. When using a fine filter, the stainless steel filter be removed.
- Features:** The device is suitable for operation with frequency inverters for speed control. If desired, the device can be equipped with a thermistor (PTC), the signal can be evaluated with an optional trip device. The tech. Data remains unchanged.
- Operating temperature:** The operating temperature of the radial pressure may **NOT exceed 60°C/140°F**. Optionally, the inlet air temperature of the fan can be raised by a single temperature lock onto a **maximum of 180°C/356°F** and with a double temperature lock onto a **maximum of 230°C/446°F**.
- Ambient temperature:** -20°C to +60 C / -4°F to +140°F.
- Voltage:** Optional 1 x 230VAC/50Hz, Capacitor 12/450µF/V (Item no.: 5103523)

### Technical data

Type:	Centrifugal fan			
Item no.:		5103527	5103531	on request
<b>Voltage</b>	VAC	(Y/Δ) 230 - 400	(Y/Δ) 277/ - 480	230
<b>Frequency</b>	Hz	50	60	50
<b>Motor power</b>	KW	0,37	0,44	0,37
<b>Current</b>	A	1,73/1,00		2,50
<b>Volume flow</b>	m <sup>3</sup> / min	16,1	16,3	16,1
<b>Total pressure difference</b>	Pa	1'470	1'590	1'400
<b>Speed</b>	rpm	2'845	3'440	2825
<b>Sound pressure level</b>	LpA (db)	76	77	76
<b>Weight</b>	kg	17,0		17,5
<b>Air intake</b>	mm	Ø 125		
<b>Air outlet</b>	mm	Ø 90 (aussen)		
<b>Dimensions</b>	mm (LxWxH)	485 x 350 x 485,5		
<b>Protection type</b>		IP 54		
<b>Conformity</b>		CE		
<b>Protection class I</b>		⏚		

Medium pressure blower type MD14

Fan characteristics

(Y/Δ) 230/400VAC, 50Hz

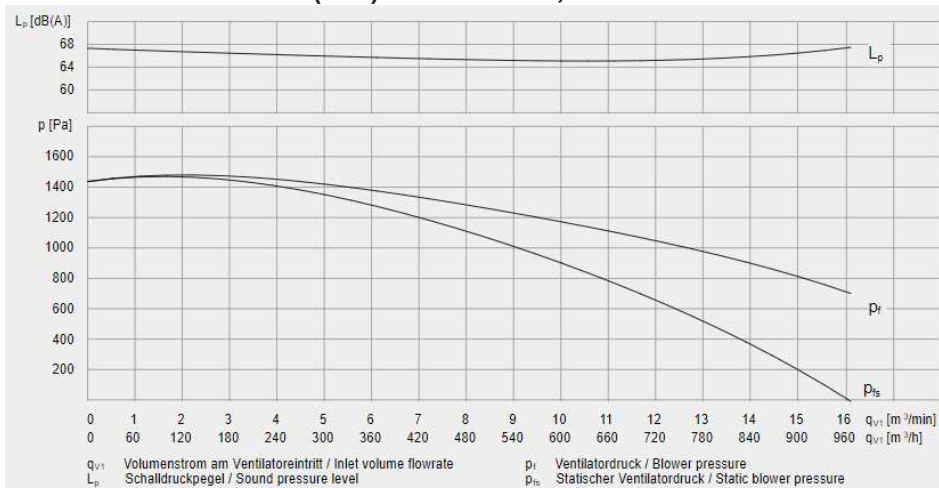

(Y/Δ) 277/480VAC, 60Hz

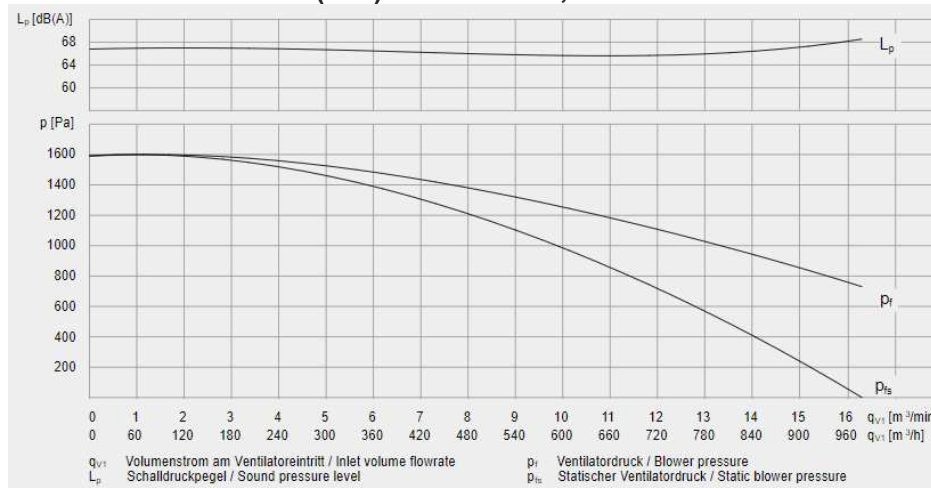













**Permissible vibration values according to ISO 14694**

Fan application category [a <sub>h</sub> ]	Rigidly mounted [mm/s <sup>2</sup> ]		Flexibly mounted [mm/s <sup>2</sup> ]	
	Peak	r.m.s.	Peak	r.m.s.
<b>BV-3</b>	<b>3,8</b>	<b>2,8</b>	<b>5,1</b>	<b>3,5</b>

## Medium pressure blower type MD14

**Accessories:**

Item no.	Description
5103523	 Motor capacitor 230 V~ with clamp and cable
5107238	 Hose connection adaptor 1 x 90mm inside / 2 x 60mm outside
5107278	 Hose connection adaptor 1 x 60mm inside / 2 x 60mm outside
5107293	 Hose connection adaptor 1 x 38mm inside / 2 x 38mm outside
5207293	 Hose connection adaptor 1 x 38mm / 2 x 38mm – with thread outside
5107281	 Hose connection adaptor 1 x 38mm inside / 3 x 14mm outside
5107298	 Hose connection adaptor 1 x 38mm inside / 2 x 19mm outside
5107288	 PVC air hose – Ø 60mm innen
5107285	 Clamp for hose Ø 60mm
5107240	 Cap for hose connection adaptor Ø 60mm
5107286	 PVC air hose – Ø 38mm innen
5107287	 Clamp for hose Ø 38mm
5107241	 Cap for hose connection adaptor Ø 38mm
5113402	Intake for MD14

Medium pressure blower type MD14

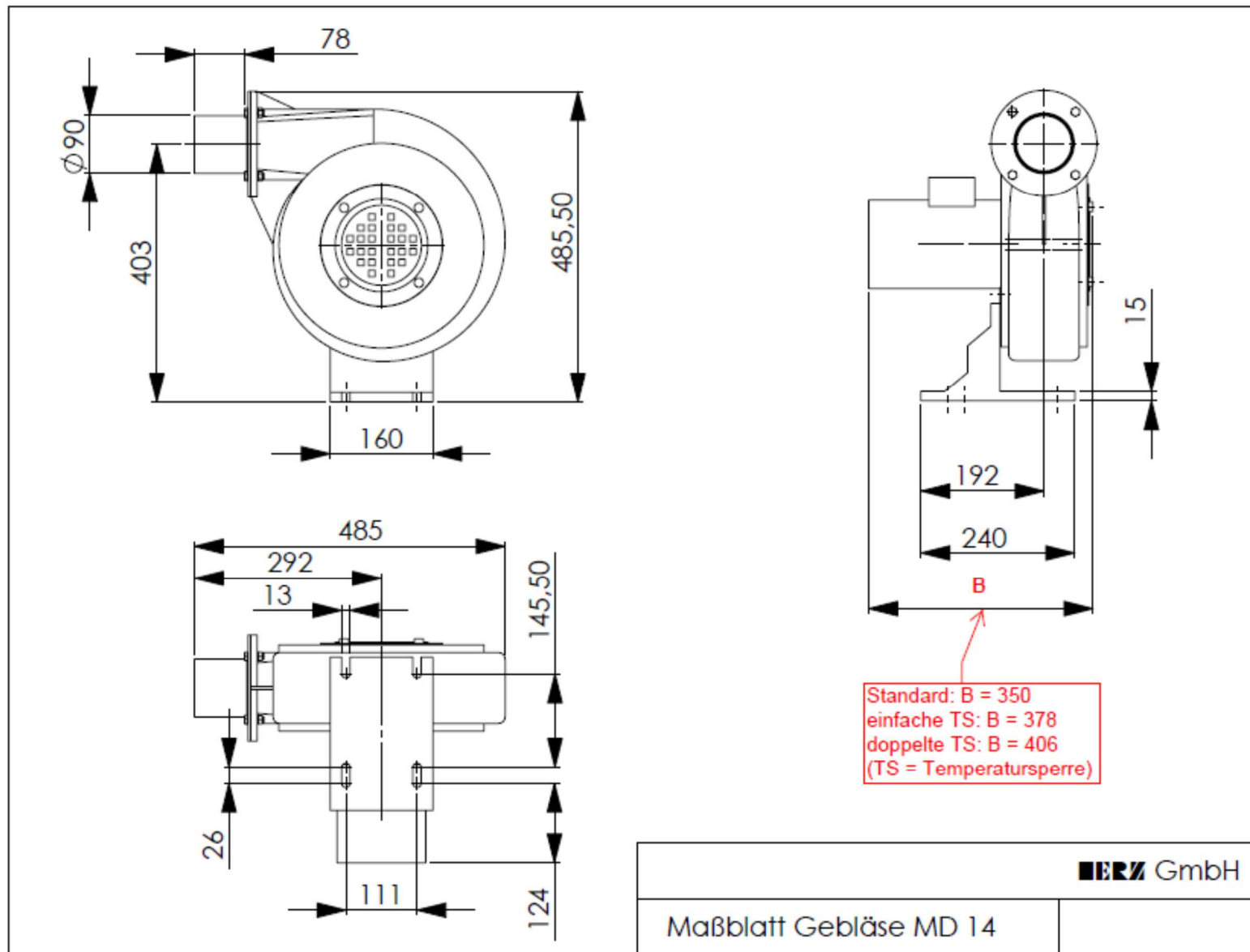

## Medium pressure blower type MD14

### **HERZ** GmbH

Kunststoff- & Wärmetechnologie  
Biberweg 1  
DE – 56566 Neuwied  
Tel.: +49 (0)2622-8855-0  
Fax: +49 (0)2622-8855-135  
Fax: +49 (0)2622-8855-136  
www.herz-gmbh.com  
info@herz-gmbh.com

### **HERZ** Austria GmbH

Kunststoff- & Wärmetechnologie  
Gleinser Weg 27  
AT – 6141 Schönberg / Tirol  
Tel.: +43 (0)5225-63113  
Fax: +43 (0)5225-6311385  
www.herz-austria.at  
herz.schoenberg@herz-gmbh.com

### **HERZ** Hungária Kft.

Műanyag- és hőlégtéchnika  
Pesti út 284  
HU – 2225 Üllő  
Tel.: +36 (06)29-522400  
Fax: +36 (06)29-522410  
www.herz-hungaria.hu  
herz@herz-hungaria.hu

### **HERZ** Bulgaria OOD

Boul. Assen Yordanov 10  
BG – 1592 Sofia  
Tel.: +359 (0)2-9790351  
www.herz-bulgaria.com  
office@herz-bulgaria.com

### **HERZ** GmbH

Kunststoff- & Wärmetechnologie  
Am Arenberg 26A  
DE – 86456 Gablingen  
Tel.: +49 (0)8230-85085  
Fax: +49 (0)8230-85087  
www.herz-gmbh.com  
robert.einberger@herz-gmbh.com

### **HERZ** Austria GmbH

Kunststoff- & Wärmetechnologie  
Johann-Galler-Str. 20 IZ – NÖ – Nord  
AT – 2120 Wolkersdorf i. Weinviertel  
Tel.: +43 (0)2245-82494-0  
Fax: +43 (0)2245-82494-9  
www.herz-austria.at  
herz.wolkersdorf@herz-gmbh.com

### **HERZ** Polska Sp.z o. o.

Technologie obróbki tworzyw sztucznych  
Ul. Kostrzyńska 30  
PL – 02-979 Warszawa  
Tel.: +48 (0)22-8428583  
Fax: +48 (0)22-8429700  
www.herz-polska.pl  
herz@herz-polska.pl

